

Country Lane Five Shelf Bookcase (Carysbrook)

Style # 956-113 (Amber Butternut) DPCI#074-09-0743

Assembly Instructions

CONGRATULATIONS

You've purchased a fine furniture product by



All of our easy-to-assembly furniture is solidly built and rigorously tested to ensure years of enjoyment.

We're here to help. Just call **1-800-782-3876** or e-mail **CISupport@Thomasville.com**

BEFORE YOU BEGIN

You may find it helpful to have a helper while assembling unit.



We've included easy to follow step-by-step instructions which have been carefully written to ensure quick, easy assembly of your furniture. Be sure to read the instructions (a time saver in the long run).

Identify all parts and hardware. If any pieces are missing call **Toll Free number 1-800-782-3876** or e-mail **CISupport@Thomasville.com** for replacement parts. For faster service, have the style number handy when calling.

Questions?

We're here to help. You may e-mail **CISupport@Thomasville.com** or call **1-800-782-3876** between **8:00a.m. - 9:00p.m., Monday - Friday** and **9:00a.m. - 5:00p.m., Saturday (Eastern Time)**. Holiday weekends will not be staffed. For faster service, have the style number handy when calling.

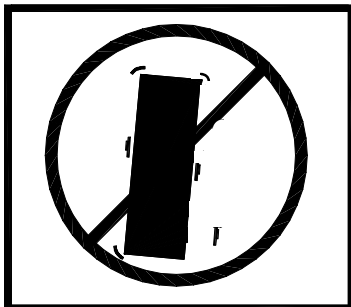

WARNING...This unit is to be used for its intended purpose. Other uses may cause product to tip.

- * **Do not allow anyone to climb on unit.**
- * **Put heavy items on lower shelves.**

Tools

You will need a standard flat-head screwdriver, Phillips head screwdriver and a hammer.

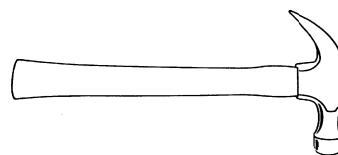
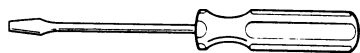

Parts List

Screws are shown actual size. Hardware may be shown smaller than actual size. Before you begin assembly, lay all pieces out on the floor according to these illustrations.

Note: For reasons of manufacturing efficiencies, you may find extra hardware and unused holes in parts.



S2 1/2" Phillips-head Screw (12)
002262

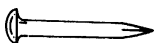

Nail (50)
002669



Cover-cap (20)
80097153

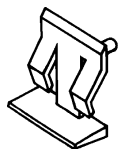

LPN Locking Shelf Pins (12)
004053



CS Long Cam Stud (12)
009612



SCS Short Cam Stud (6)
009611

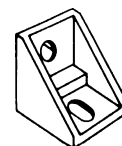

LB Plastic L-Bracket (6)
001136



CH Cam Housing (18)
009613



Touch Up Pen (1)
80085010

Note: All parts may not be identified with labels, but to help identify certain parts, you may see one or more types of labelling. One type is the peel-off label and the other is an ink-print on one of the unfinished edges.

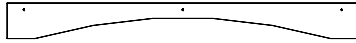

I Top Front Molding (1)
 25-1/16" x 2-9/16"
 092512TF

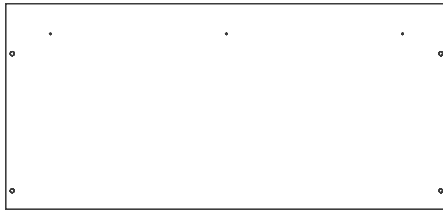

A Top (1)
 28-9/16" x 13-3/16"
 012825TF

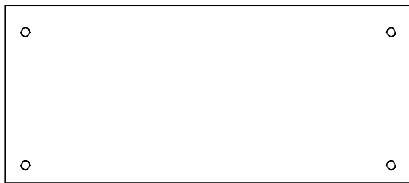

F Stationary Shelf (1)
 26-15/16" x 11-5/8"
 062737TF

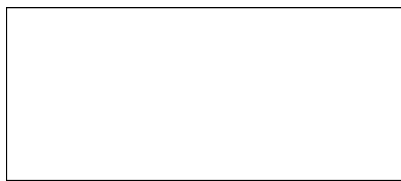

F1 Adjustable Shelf (3)
 26-3/4" x 11-5/8"
 062738TF

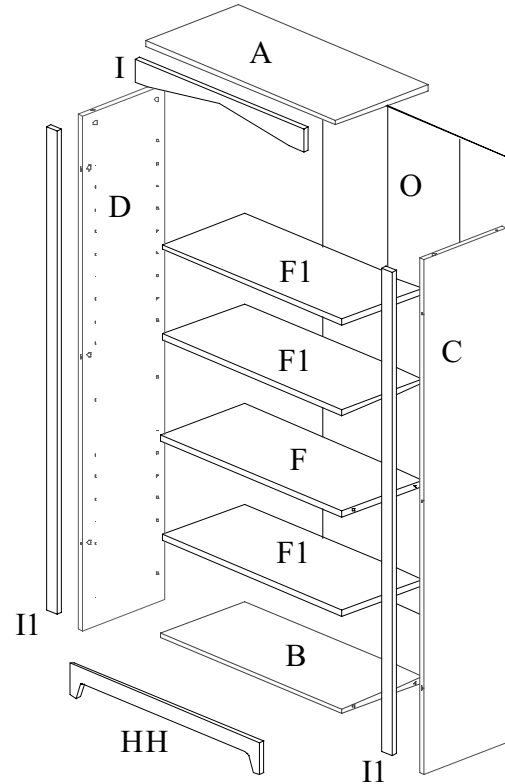

B Bottom (1)
 26-15/16" x 11-3/4"
 022718TF

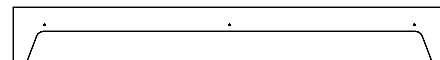

HH Bottom Front Molding (1)
 28-3/8" x 3-9/16"
 342825TF

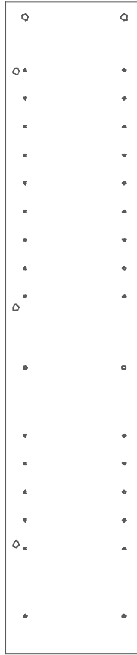

D Left Side (1)
58" x 11-3/4"
045819TF

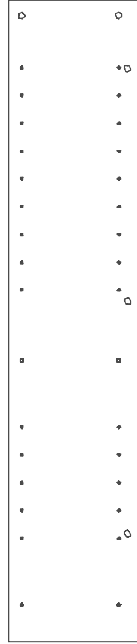

C Right Side (1)
58" x 11-3/4"
035819TF

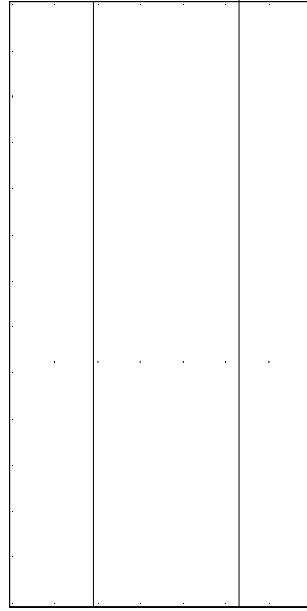

O Back Panel (1)
55-9/16" x 28"
80100452



I1 Vertical Rails (2)
54-3/8" x 1-5/8"
095421TF

1

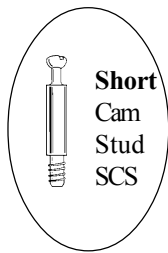

**Short
Cam
Stud
SCS**

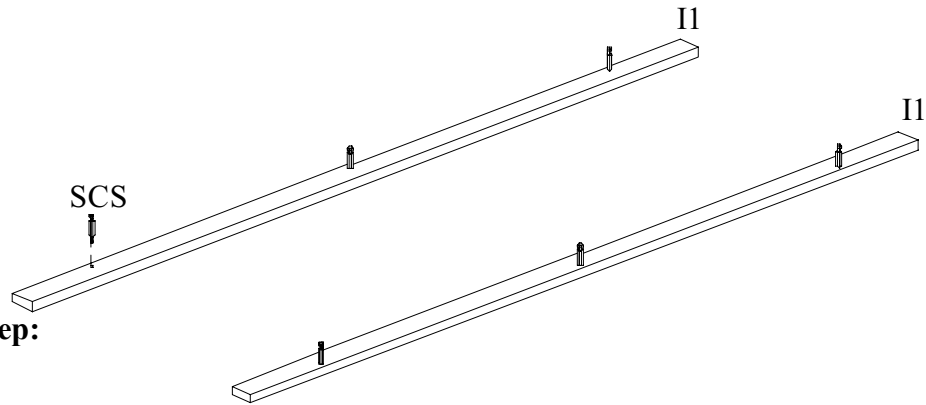

Parts needed for this step:
(2) Vertical Rails (I1).

Hardware needed for this step:
(6) **Short Cam Studs (SCS).**

Action Required:

- * Place vertical rails (I1), as shown, in diagram.
- * Screw (6) **short** cam studs (SCS) into the holes, as shown, in vertical rails (I1).

2

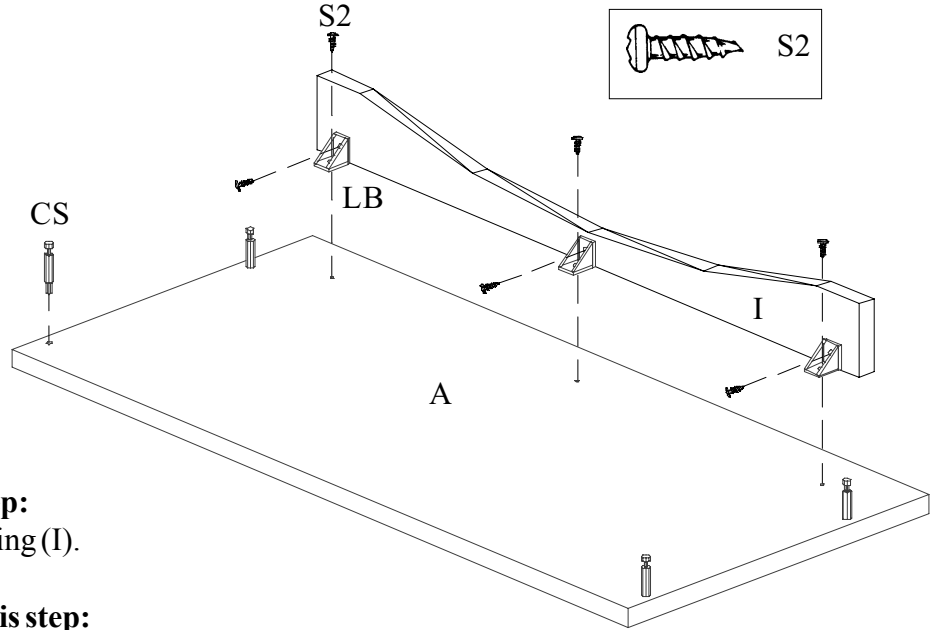
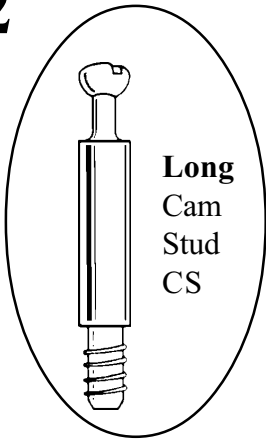

Parts needed for this step:

Top (A), Top Front Molding (I).

Hardware needed for this step:

(4) Long Cam Studs (CS), (3) L-Brackets (LB), (6) Round-Head Screws (S2).

Action Required:

- * Screw (4) **long** cam studs (CS) into the holes, as shown, in top (A).
- * Attach (3) L-Brackets (LB) to top front molding (I), using (3) round-head screws (S2).
- * **Loosely**, attach top front molding (I) to top (A), using (3) round-head screws (S2).

3

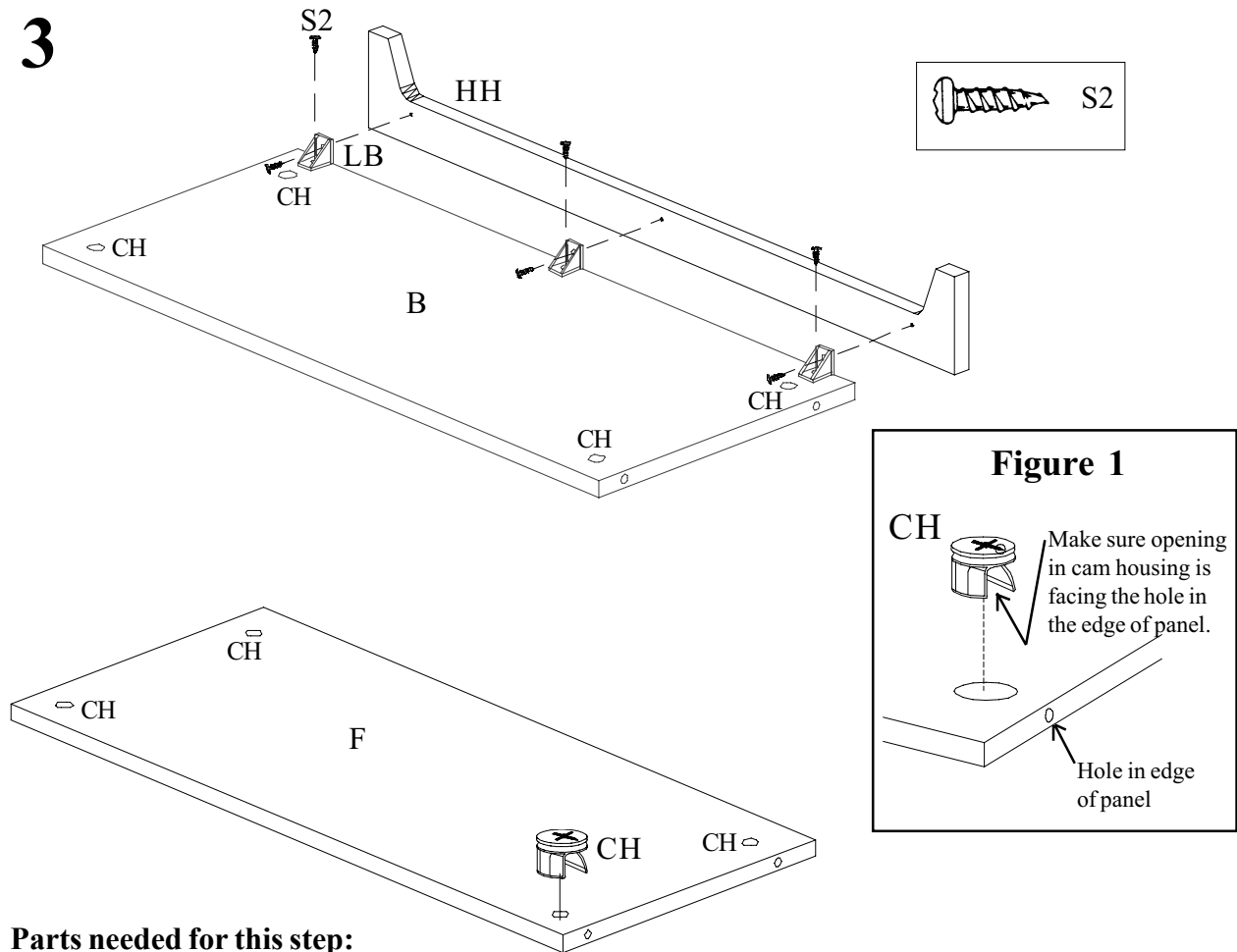

Parts needed for this step:

Bottom (B), Bottom Front Molding (HH), Stationary Shelf (F).

Hardware needed for this step:

(8) Cam Housings (CH), (3) L-Brackets (LB), (6) Round-Head Screws (S2).

Action Required:

* **SEE FIGURE 1**...Insert (8) cam housings (CH) into the holes, as shown, in bottom (B) and shelf (F).

Press with thumb to fully seat cam housings.

* Attach (3) L-Brackets (LB) to bottom (B), using (3) round-head screws (S2).

* **Loosely**, attach bottom front molding (HH) to bottom (B), using (3) round-head screws (S2).

4

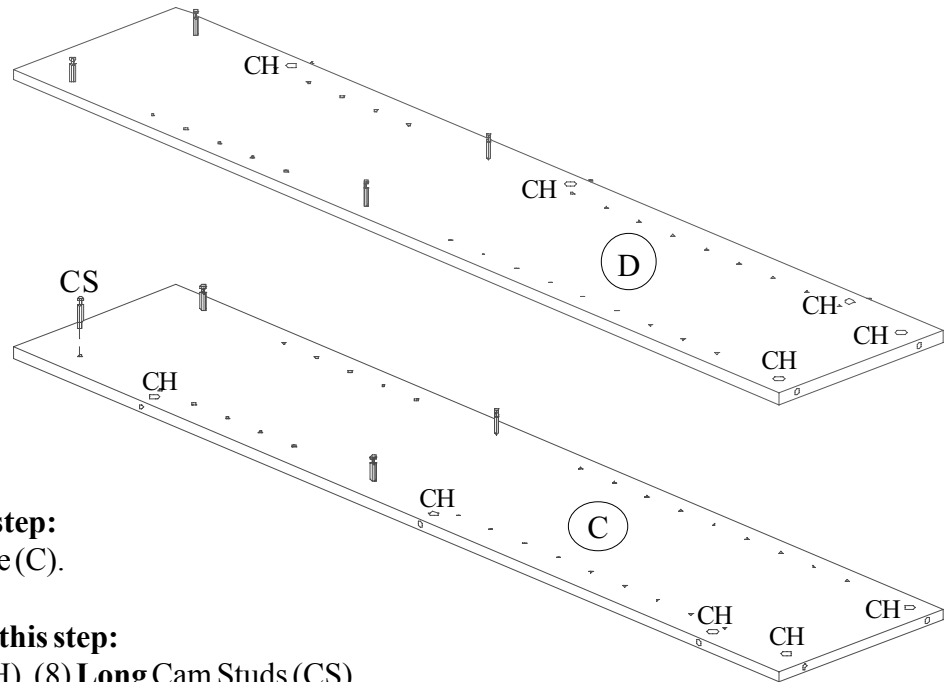

Parts needed for this step:

Left Side (D), Right Side (C).

Hardware needed for this step:

(10) Cam Housings (CH), (8) Long Cam Studs (CS).

Action Required:

- * Insert (10) cam housings (CH) into the holes, as shown, in left and right sides (D & C).
- * Screw (8) long cam studs (CS) into the holes, as shown, in left and right sides (D & C).

5

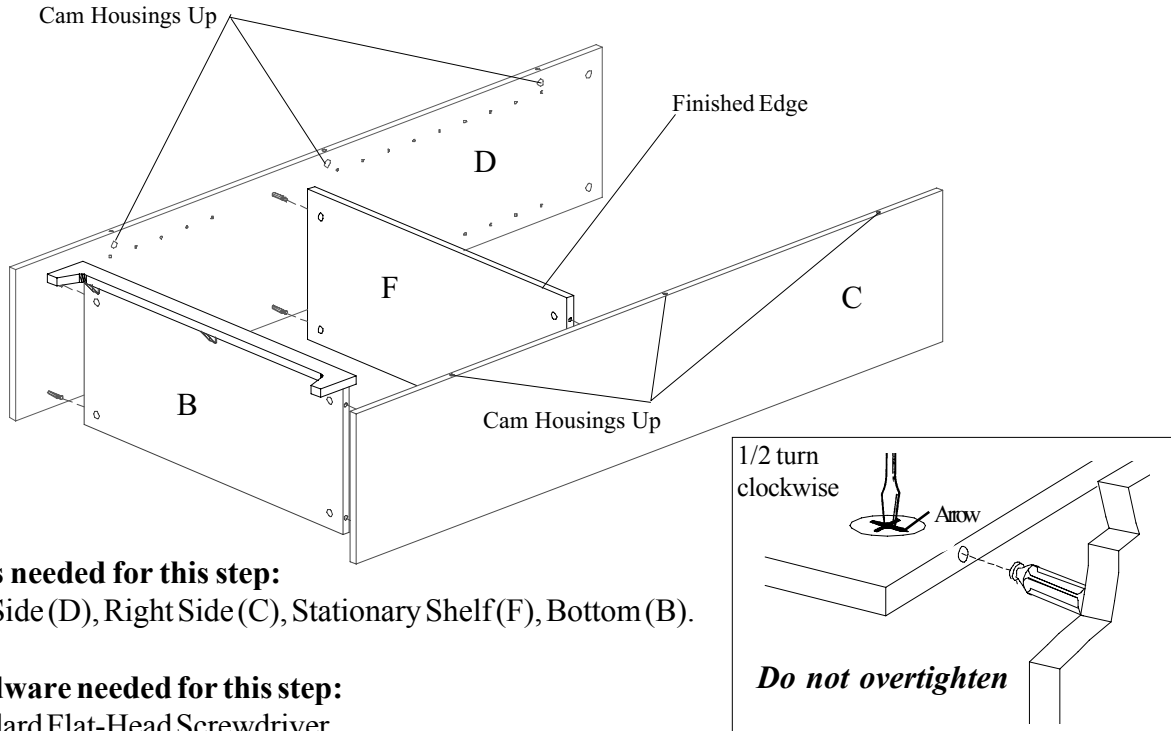

Parts needed for this step:

Left Side (D), Right Side (C), Stationary Shelf (F), Bottom (B).

Hardware needed for this step:

Standard Flat-Head Screwdriver.

Action Required:

* With a helper, attach shelf (F), **finished edge up**, and bottom (B) to left side (D).

Note: Cam Housings in side (D) should be up and facing inside, as shown.

* Lock cam housings with a half turn clockwise of a standard flat-head screwdriver.

* Attach right side (C), **as shown with cam housings up and facing inside**, to shelf (F) and bottom (B).

* Lock cam housings.

6

Action Required:

* Attach top (A) to left and right sides (D & C).

* Lock cam housings with a half turn clockwise of a standard flat-head screwdriver.

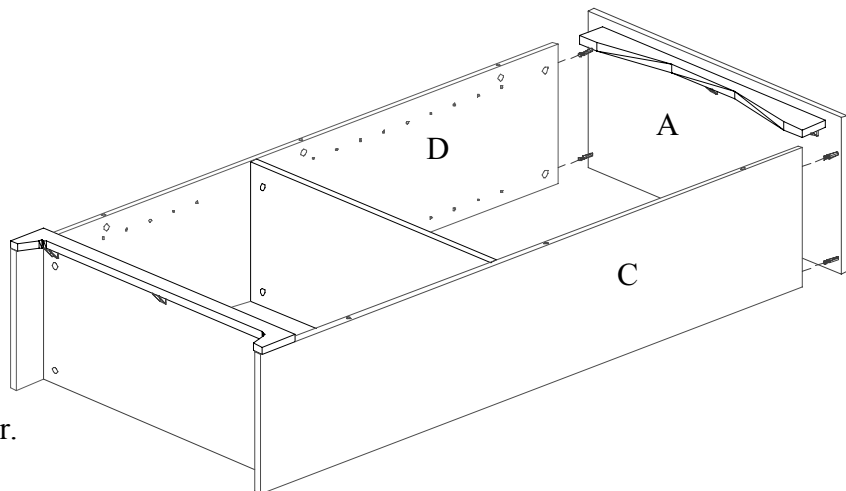

7

Parts needed for this step:

(2) Vertical Rails (I1).

Hardware needed for this step:

Standard Flat-Head
Screwdriver.

Action Required:

* **SEE HELPFUL HINT...**

Attach vertical rails (I1) to left and right
sides (D & C).

* Lock cam housings.

* Tighten screws in L-Brackets in top front molding
(I) and bottom front molding (HH).

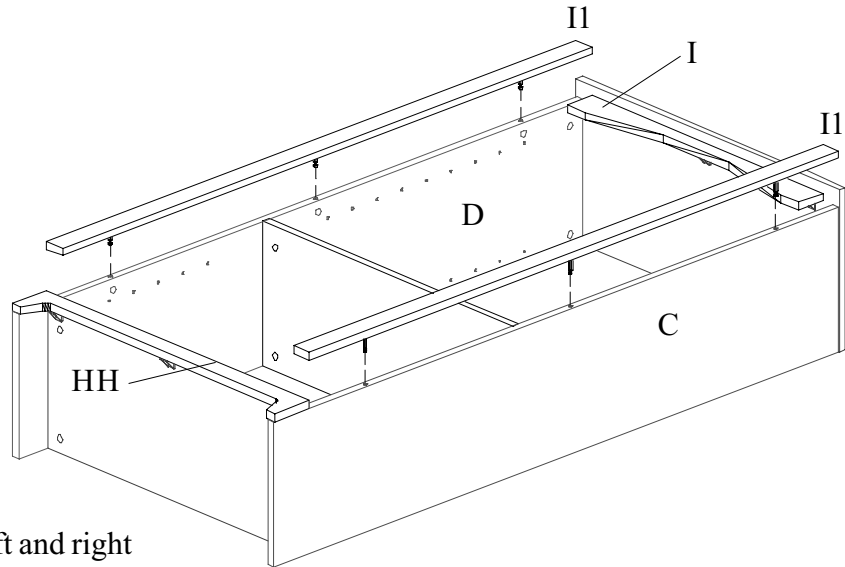

Helpful Hint...

Vertical rails (I1) should overhang
to the inside of the case.

8

Note: Back panel adds
stability to case.

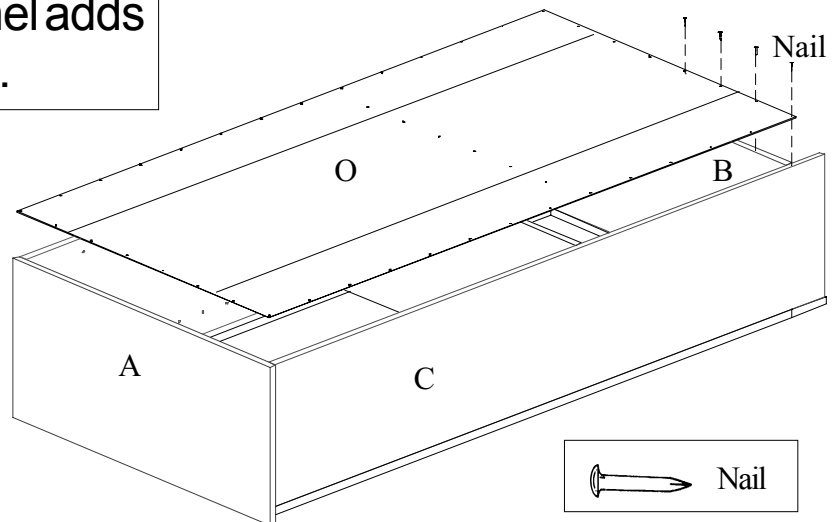

Parts needed for this step:

Back Panel (O).

Hardware needed for this step:

Nails.

Action Required:

* With a helper, carefully turn unit over with the front against the floor.

* Position back panel (O), **finished side down**, even with the bottom edge of bottom (B).

* Make sure panel (O) fits square and even side to side. **If it doesn't, adjust unit into square by pushing or pulling on one corner of the unit until back panel fits squarely.**

* While nailing into pilot holes, take care to hammer nails in straight.

9

Parts needed for this step:

(3) Adjustable Shelves (F1).

Hardware needed for this step:

(12) Locking Shelf Pins (LPN).

Action Required:

- * To install adjustable shelves (F1), push locking shelf pins (LPN) into the holes at the height you desire.
- * Position the shelves so they rest on top of the locking shelf pins and push down to lock in place.

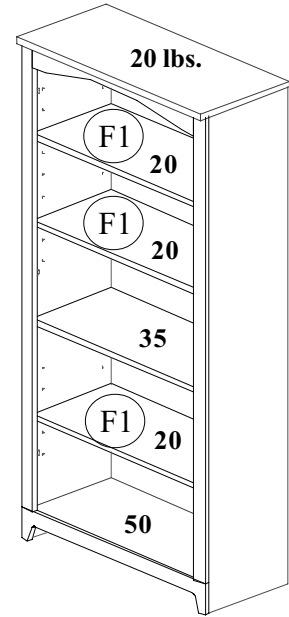
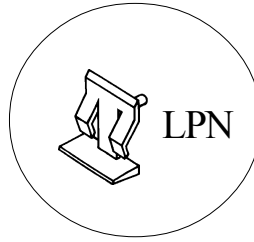

THIS UNIT HAS BEEN DESIGNED FOR THE WEIGHTS SHOWN. EXCEEDING THESE RECOMMENDED WEIGHTS COULD RESULT IN EXCESSIVE "SAGGING" OF THE SHELF. EXTREME OVERLOADING COULD CAUSE FAILURE OF THE SHELF AND POSSIBLE INJURY.

Note: Make sure all cam housings are in the locked position.

10

* Decorative cover caps are provided to cover exposed cam housings.

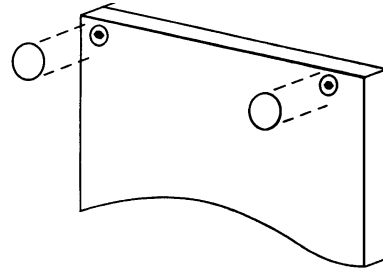

A touch-up pen has been provided for any touch up needed.

That's it! You've finished assembling your Five Shelf Bookcase by



MRP- 80110954 (Carysbrook)
1004